



INTEGRAL AUDIO

INSTALLATION GUIDE

SOUNDSTAGE + SUBWOOFER SYSTEM MINI COOPER CLUBMAN (R55) ver. 5/2017

SKILL LEVEL REQUIRED
DO-IT-YOURSELF
INSTALLATION DIFFICULTY
3 OUT OF 5
INSTALLATION TIME
6-8 HOURS

APPLIES TO

2007+ R55 STANDARD 6 SPEAKER
2007+ R55 HIFI/HK



- OVERVIEW** 2
- BEFORE YOU BEGIN** 2
- WHAT'S IN THE BOX - SOUNDSTAGE** 3
- WHAT'S IN THE BOX - SUBWOOFER** 4
- TOOLS YOU WILL NEED** 5
- INSTALLATION:**
- A. Prep Vehicle 6
- B. Power & Ground Wiring 7
- C. Signal Wiring 8
- D. Amplifier Installation & Speaker wiring 9
- E. Soundstage speaker installation 11
- F. Install the Subwoofer [sub only] 14
- G. Testing & Recommended Initial Settings 16
- TIPS & TUNING** 18
- TROUBLESHOOTING** 18

IMPORTANT

- Read this Guide completely BEFORE you begin.
- Disconnect the battery negative terminal while working on the vehicle.
- DO NOT PLACE THE KEY FOB in the vehicle with the battery connected and the seat airbag wiring disconnected. Doing so will set off the airbag light, and must be reset by your dealer.
- ALWAYS check behind panels and components before drilling, cutting, or screwing into any part of a vehicle.
- This guide covers several different vehicle models and options. Some steps only apply to certain installations. Steps images are labeled with a black bar across the top:
 - **[6SPK ONLY]** apply only to vehicles equipped with the standard 6 speaker audio system.
 - **[HIFI/HK ONLY]** apply only to vehicles equipped with the upgraded 10 speaker HIFI and Harmon Kardon audio system. If the vehicle has tweeters in the A-pillar (near the bottom outer corners of the windshield), you have the HIFI or HK systems.
 - **[SUB ONLY]** apply only if you are installing the Integral Audio Subwoofer System
 - If there is no label, the step applies to ALL installations
 - Because each kit applies to more than one vehicle, your kit may include extra items.

- I. SOUNDSTAGE SPEAKER PACKAGE**
 1. IASS-T 1" Silk Dome Tweeter (Pair)
 2. IASS-4 4" Midrange (Pair)
 3. IASS-6 6" Midwoofer (Pair)
- II. SOUNDSTAGE CROSSOVER NETWORKS WITH VEHICLE-SPECIFIC TUNING & EQUALIZATION**
 4. MCSS630MW Mid-Woofer Network (Pair)
 5. MCSS630T Tweeter Network (Pair)
- III. ARC AUDIO KS MINI AMPLIFIER (2CH W/SOUNDSTAGE, 4CH W/SOUNDSTAGE + SUBWOOFER)**
- IV. SIGNAL & SPEAKER WIRING HARNESSES**
 6. Signal Wiring Harness (MCWH-SIG-R)
 7. Mid-Woofer Connection Harness (Pair)
 8. Tweeter Pigtail (Pair)
- V. SOUNDSTAGE HARDWARE**
 9. Midrange Mounting Adapter (Pair)
 10. Midwoofer Mounting Adapter (Pair)
 11. #8 x 1/2" Midwoofer Mounting Screws (12)
 12. #6 x 3/8" Midrange Mounting Screws (12)
 13. Integral Audio Logo Badge (Pair)
- VI. AMPLIFIER INSTALLATION & WIRING**
 14. Amplifier Power Wiring Harness (complete)
 15. Threadlock Wire Splice Connectors (4) [HIFI/HK ONLY]
 16. Threadlock Wire Tap (1)
 17. Cable Ties (10)
 18. 3M Electrical Tape
- VII. AMPLIFIER MOUNTING (UNDERSEAT AMP MOUNT)**
 19. Amplifier Mounting Bracket
 20. #6 x 3/8" Pan Head Screw (4)
- VIII. MULTIFUNCTION BOX COVER (UNDERSEAT COVER) [OPTIONAL]**
- IX. FACTORY A-PILLAR TRIM W/TWEETER MOUNTS [OPTIONAL]**

- X. MC800S SUBWOOFER ENCLOSURE
- XI. INTEGRAL AUDIO ALCHEMY 10" SUBWOOFER
- XII. SPARE TIRE WELL COVER PANEL
- XIII. SUBWOOFER HARDWARE

- 21. Neutrik Speak-On Terminal & Gasket
- 22. ¼" x 1" Hex Head Bolt
- 23. #10 x 1" Black Pan Head Screw (8)
- 24. #10 x ¾" Pan Head Screw (8)
- 25. #4 x ½" Black Flathead Screw (2)
- 26. Threaded Insert (3)
- 27. Threaded Insert Installation Wrench
- 28. Subwoofer Mounting Bracket (2)
- 29. Rosette Thumbscrew (2)
- 30. Connection Harness (Sub to Neutrik)

XIV. REMOTE LEVEL CONTROL

- 31. Integral Audio Remote Level Control
- 32. 3M VHB Double-Sided Mounting Tape (3in)

Select Hardware for Identification:

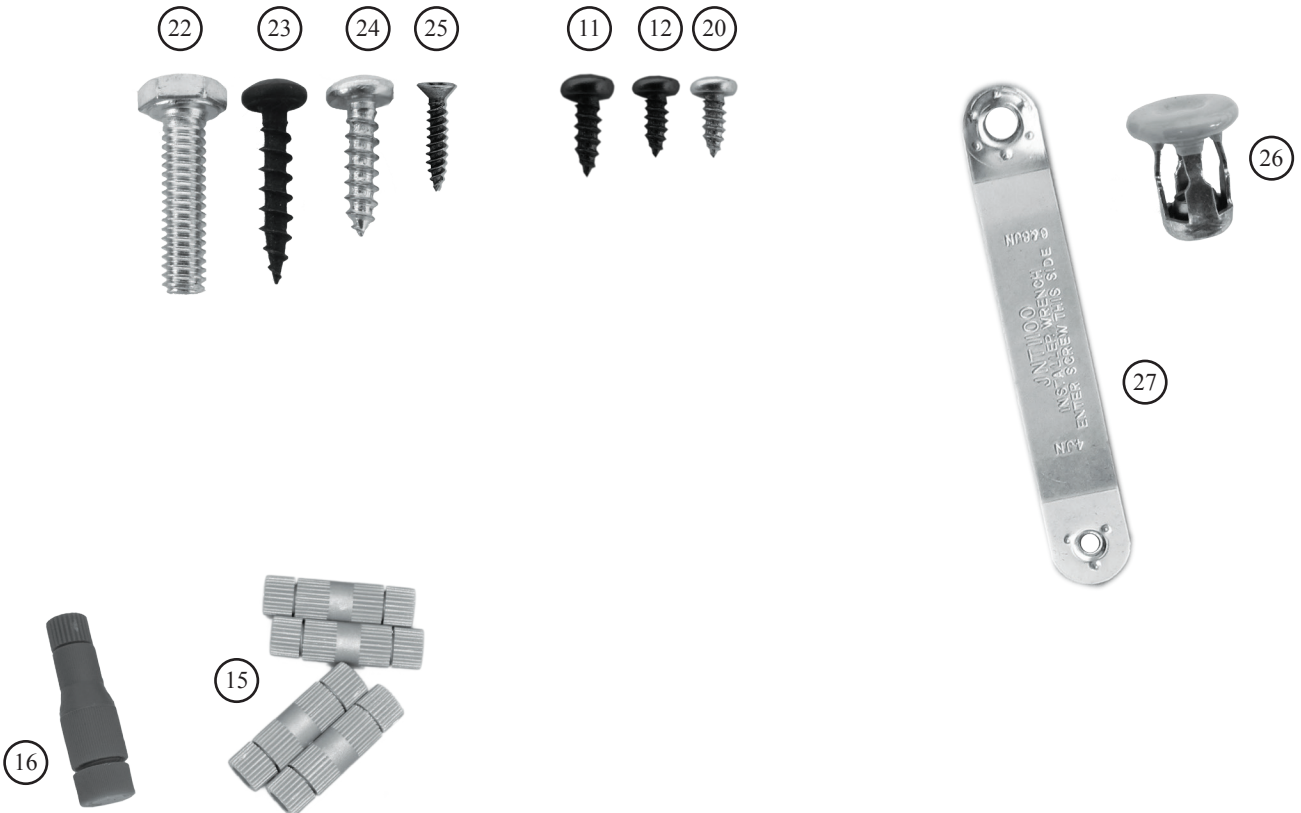

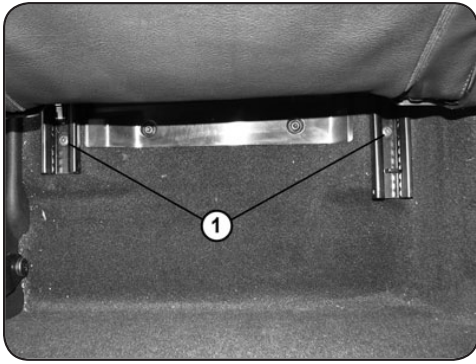

1. REMOVE PASSENGER SEAT

Slide the seat forward. Using a Torx T-40, remove the two screws holding the rear of the seat (1). Slide the seat backward and repeat for the two front screws.

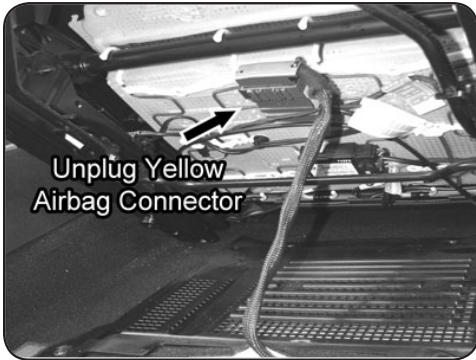

2. REMOVE PASSENGER SEAT (PART 2)

Tilt the seat back. Disconnect the airbag wiring under the seat by pulling the black slide catch on the side of the yellow plug. Disconnect the seat heater wiring if equipped. DO NOT put the key FOB in the ignition while this plug is disconnected. Remove the seat from the vehicle.

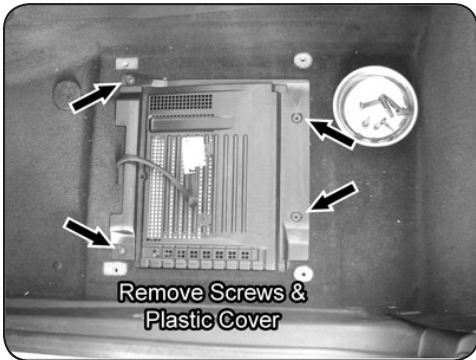

3. REMOVE PASSENGER SEAT (PART 3)

If present, remove the plastic panel under the seat.

SEE PREVIOUS IMAGES

4. REMOVE DRIVER SEAT

Repeat the previous steps to remove the Driver seat.

[This step is not absolutely necessary, but it does make later steps easier and is recommended.]

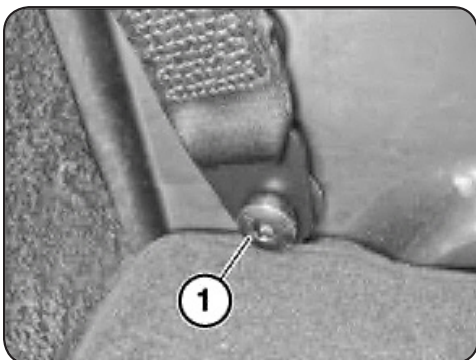

5. REMOVE LEFT DOOR SILL TRIM (PART 1)

Using a Torx T-50 bit, remove the seat belt screw (1) where it passes through the rear of the door sill trim.

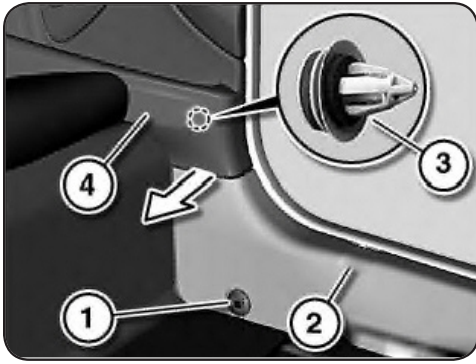

6. REMOVE LEFT DOOR SILL TRIM (PART 2)

Remove metal seat belt bushing (1) if not removed in the previous step. Pull Rear Side Trim Panel (4) in, releasing clip (3) and freeing tab of Door Sill (2) located behind Side Panel (4).

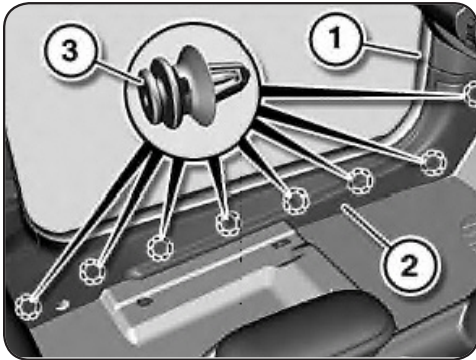

7. REMOVE LEFT DOOR SILL TRIM (PART 3)

[Seat shown removed for clarity]

Remove the door seal over the entire length of the right door sill by lifting it up and off. Pull up/loosen the rubber door seal gasket along the length of the door. Pull Door Sill Panel (2) inward, releasing clips (3). This requires a firm pull at each of the clip locations. Remove the small trim piece (1) by pulling it toward the rear of the vehicle, releasing spring clip.

SEE PREVIOUS IMAGES

8. REMOVE THE RIGHT DOOR SILL TRIM

Repeat the previous three steps for the Right Side of the vehicle.



9. RELEASE FRONT OF THE REAR SEAT BOTTOM

Pull up firmly on the front of the edge of the rear seat bottom to release. This will allow you access underneath the carpet in later steps.

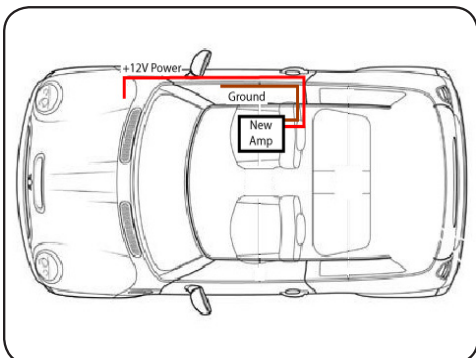

10. POWER & GROUND WIRING (OVERVIEW)

The 12V+ wire runs directly from the battery to the new amplifier that installs under the passenger seat. An inline fuse is installed at the battery.

The Ground wire runs from the amplifier to one of the factory-installed common ground points along the door sill

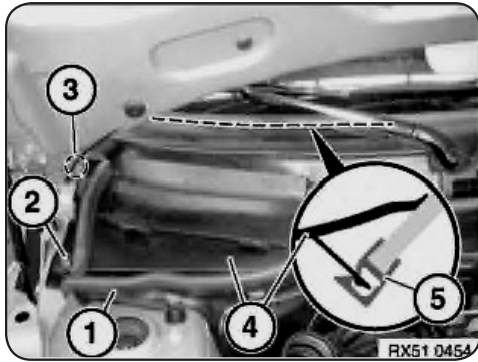

11. REMOVE RIGHT COWL PANEL

Open the Bonnet (aka the hood!). Remove the black plastic Cowl covering the battery by releasing nuts (2) and (3) with a 10mm socket. Loosen & remove cowl.

NOTE: When replacing the cowl, be sure the seal (1) is seated properly and that the secondary tab of the cowl (4) is inserted into the plastic channel (5) that attaches to the bottom of the windshield.

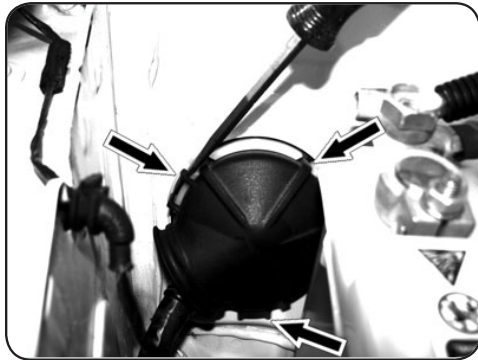

12. REMOVE THRU-WALL COVER

Remove the battery.

Locate the thru-wall bushing behind the battery. Using a flat screwdriver, release the indicated retaining tabs then remove the plastic thru-wall cover to expose the thru-wall opening.

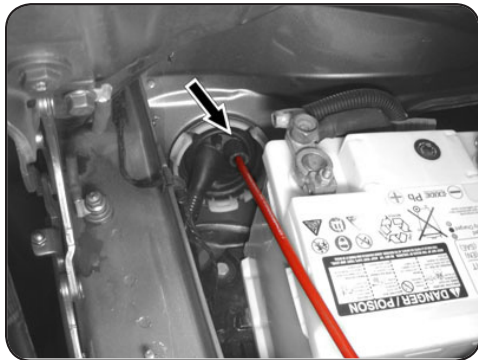

13. POWER WIRE

Locate the Power Wire (with fuse holder) in the amp wiring kit. REMOVE THE FUSE IF INSTALLED IN THE HOLDER! Feed the Red Power Wire through the spare wiring nipple and into the cabin. From inside the vehicle, locate the wire coming in. Feed the wire around the fuse box and along the Right Door Sill.

Remove the auxiliary nut on the battery post with a 19mm socket and attach the ring terminal on the end of the power wire.

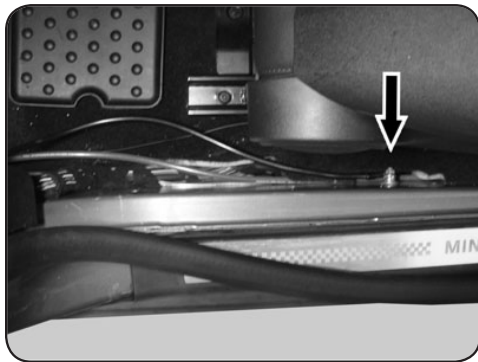

14. GROUND WIRE

Locate the Common Ground point under the Right Door Sill. Remove the nut with a 10mm socket. Attach the ring terminal of the Black Ground Wire to the Common Ground point.

NOTE: On some vehicles the common ground is located a bit further forward. Enough ground wire is included to reach either location.

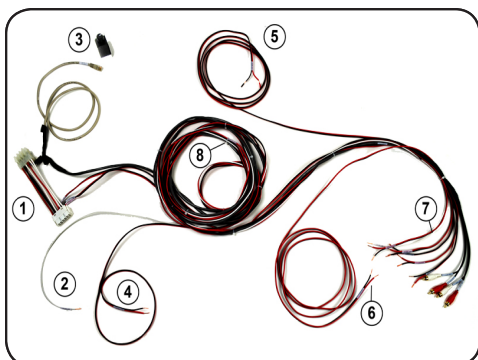

15. SIGNAL WIRING HARNESS (OVERVIEW)

The signal wiring harness contains all wiring for low and high level signals, remote volume, and remote turn on. Items are:

(1) X9331 T-harness; (2) Remote turn-on wire; (3) Subwoofer remote volume control; (4) Left Tweeter speaker wire; (5) Right Tweeter speaker wire; (6) Subwoofer speaker wire; (7) RCA & Speaker wire connections to ARC Amplifier; (8) Inline labels for HIFI/HK systems

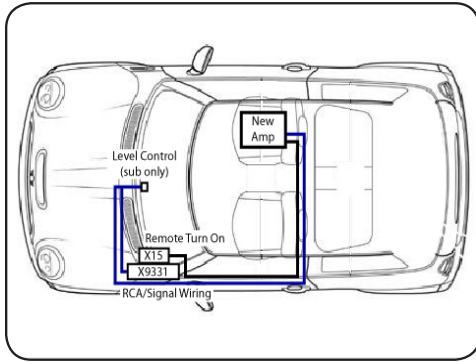

16. SIGNAL WIRING (OVERVIEW)

The factory audio signal is obtained from the X9331 connector in the driver-side footwell, described below. The X9331 T-harness portion of the signal wiring harness plugs into each side of the factory connector, and sends the signal to and from the new ARC amplifier in the rear. The 'remote volume' branch of the harness is routed to the center console.

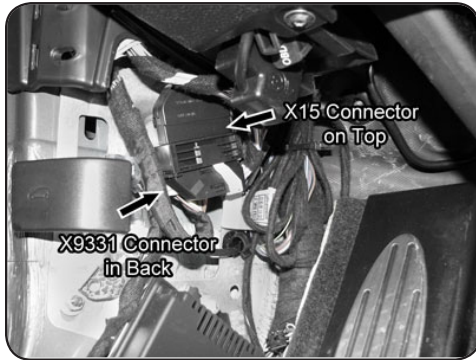

17. ACCESS X9331 & X15 CONNECTORS

Locate these connectors in the left footwell, above the dead pedal. The X9331 is behind and attached to the larger X15. Remove both by twisting counter-clockwise ¼ turn and pulling outwards. Separate the X9331 from the X15 by releasing the locking tabs on the connector joining them.

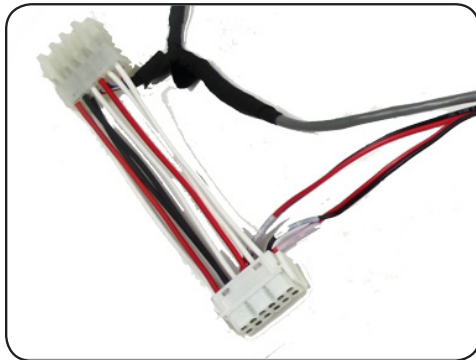

18. CONNECT X9331 T-HARNESS

Unplug the X9331 connector and connect the T-Harness. The RCA Jacks are the OUTPUT from the factory stereo - in later steps they will be connected to the INPUT on the remote level control [sub only] and the amplifier. Red = Right Channel, White = Left Channel. Both reds and both whites carry the same signal and are interchangeable. The stripped wire ends are SPEAKER INPUT and will be connected to the amplifier OUTPUT. The left channel is labeled.

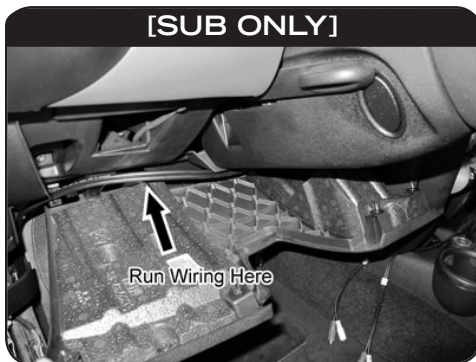

[SUB ONLY]

19. REMOTE LEVEL CONTROL

[SUB ONLY]

[NOTE: IF YOU PLAN TO INSTALL THE SUBWOOFER LATER, GO AHEAD AND RUN THIS CABLE NOW]

Locate the Remote Volume control cable. Pull firmly on the top of the plastic panel under the steering wheel to release the top edge of the panel. Feed the Remote Volume cable along and under the knee bolster.

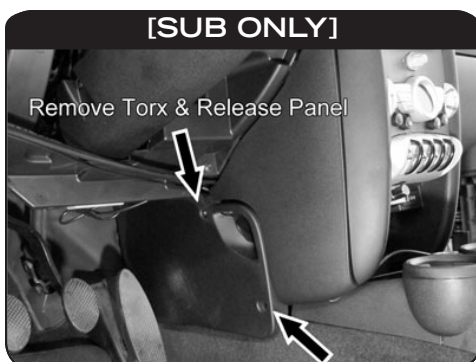

[SUB ONLY]

20. REMOVE FOOTWELL PANEL

[SUB ONLY]

Remove the panel next to gas pedal by releasing the Torx T-25 screws (some vehicles have phillips head screws) and pulling the panel out and towards the rear of the vehicle.

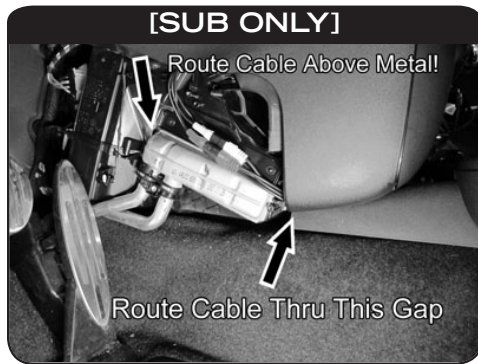

21. ROUTE REMOTE LEVEL CONTROL

[SUB ONLY]

Run the Remote Level Control cable above the metal shown and then thru the gap under the bottom edge of the center console.



. REMOTE LEVEL CONTROL

[SUB ONLY]

Assemble the Remote Level Control by inserting shaft-first into the housing and fastening with the washers and nut. Slide the knob over the shaft.

Attach the 3M VHB double-sided adhesive (this is the green 3in length) to the top of the Remote Level Control housing. Trim extra length from the VHB, if necessary. Wipe the surface with one of the Alcohol Prep Pads before applying.



22. MOUNT REMOTE LEVEL CONTROL

[SUB ONLY]

Connect the cable to the Remote Level Control. Mount the Remote Level Control below the toggle switches. Wipe the surface with the Alcohol Prep Pad before applying.

Do a dry-run to check the placement and be sure you know exactly where you'd like the control. You will find that you can place it more toward the front of the recess for easier access, or toward the rear for a more hidden look.



23. CUT & RELEASE MID/MIDWOOFER SPEAKER WIRES

[HIFI/HK ONLY] [HIFI/HK ONLY] [HIFI/HK ONLY] [HIFI/HK ONLY]
For HIFI/HK equipped vehicles ONLY!

Cut the Mid/Woofers Speaker wires at the X9331 T-Harness. Remove the wires from the rest of the harness bundle UP TO WITHIN 8 FEET OF THE RCAS at the other end of the harness. These wires will be used later to connect to the factory wiring downstream of the HIFI/HK amplifier.

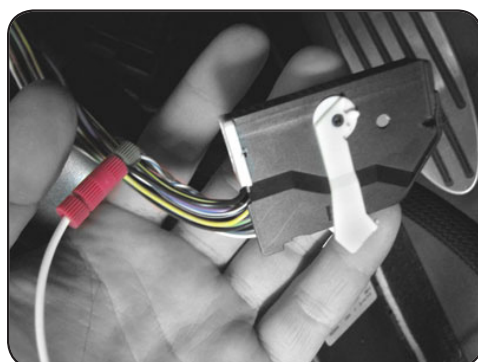

24. REMOTE TURN-ON WIRE

Identify the solid black wire coming out of pin 1 of the X15 connector (from previous step). Locate the 18AWG White Remote turn-on Lead wire in the signal harness. Unscrew both ends of the Threadlock wiretap (the tap has a hole in only one end) Slip the "U"-shaped bottom around the signal wire to be tapped. Carefully thread the body of the tap onto this and tighten firmly. Be sure not to cross-thread the tap.

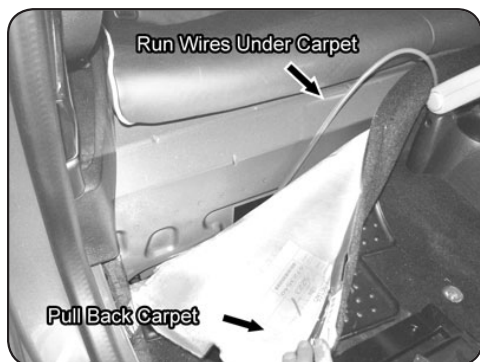

25. RUN SIGNAL WIRING TO AMP

Beginning in the left (driver's) side footwell, run the amplifier end of the signal wiring bundle along the door sill, and under the carpet in the rear seat footwell area. power/ground wires. Be sure the wiring is clear of all pinch points, including the Seat Belt screw.

AVOID PLACING SIGNAL WIRING DIRECTLY ADJACENT TO OR TOUCHING OTHER WIRING BUNDLES!

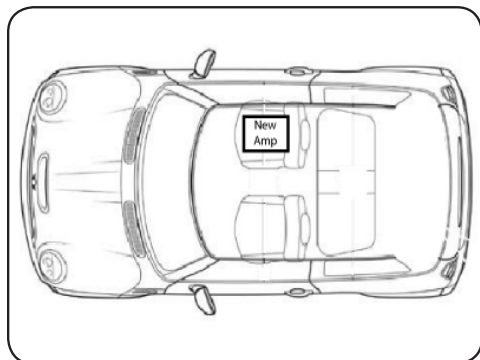

26. AMPLIFIER MOUNTING (OVERVIEW)

The amplifier mounts in the compartment under the passenger seat. If your vehicle does not have a compartment with cover under the seat, one has been included in your kit. You will cut the carpet, remove the foam block inside, and then mount the amp.

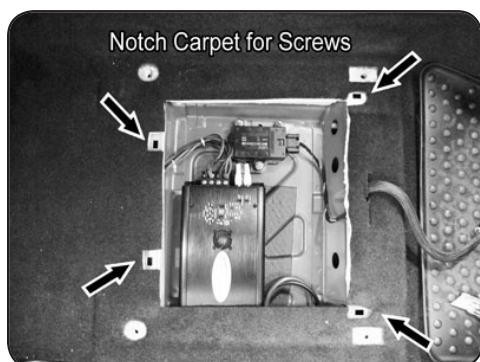

27. TRIM CARPET FOR COMPARTMENT COVER

[FOR VEHICLES WITH CARPET UNDER SEAT]

Lay the Multifunction Box Cover on the area underseat. Mark where the carpet needs to be cut with tape. Cut carpet and foam backing with a utility knife. Cut CAREFULLY - there are wires along the front edge of the compartment. The carpet should be cut SMALLER than the cover or there will be exposed area. If in doubt, remove the drivers seat and compare to the factory cut. Notch the carpet in the mounting screw areas.

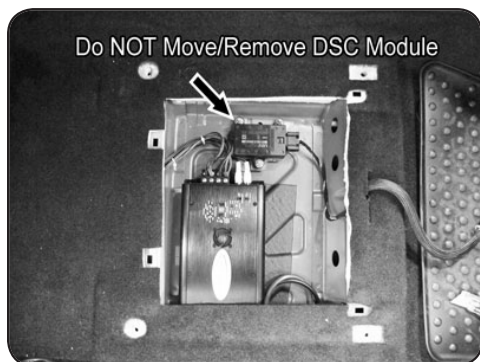

28. REMOVE THE PLASTIC TUB

[FOR VEHICLES WITH EXISTING PLASTIC COVER]

Remove the plastic tub liner from the compartment. Detach any equipment mounted to it.

DO NOT remove or remount the DSC module (see image)

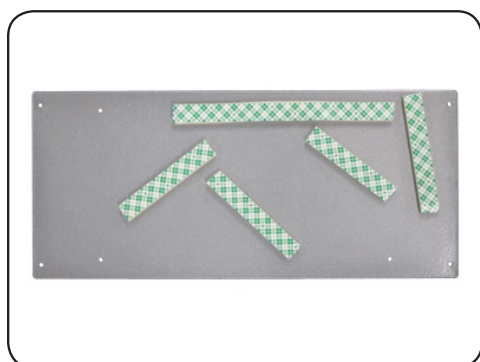

29. ATTACH AMPLIFIER MOUNTING PLATE

Cut strips of the 3M Double-Sided Foam Mounting tape and affix one side to the back of the amp mounting plate and any original equipment from the underseat compartment. Arrange all components so that they fit. Clean all components and the sheet metal with an Alcohol Prep Pad prior to attaching the Foam Mounting Tape.

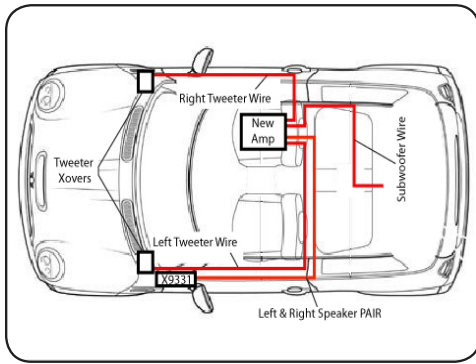

30. SPEAKER WIRING (OVERVIEW)

The front channels of the ARC amplifier drive the front tweeter and midrange/midwoofer in parallel. The rear channels drive the subwoofer. The factory HU/Amp continues to drive the rear fill speakers. In Standard 6 speaker vehicles, the signal wiring harness feeds the door midrange and midwoofer via the X9331 T-harness. In HiFi/HK equipped vehicles, a separate connection is made to the factory wiring downstream of the HiFi/HK amplifier. There are separate wires for the tweeters in all vehicles.



31. AMPLIFIER TO SPEAKER OUTPUT CONNECTIONS

Connect BOTH the Left Tweeter wire AND the Left Midrange/Midwoofer wires to the Left channel of the ARC amplifier. Repeat for the right channel. YOU WILL HAVE TWO WIRES IN EACH OF THE HOLES.

[SUB ONLY] Connect the Subwoofer wire to the rear channels in the “bridged” configuration as shown on amp. YOU WILL HAVE ONE WIRE IN EACH OF THE OUTER HOLES.

NOTE: 2ch amp shown. The 4ch has 2 rows of speaker outputs.

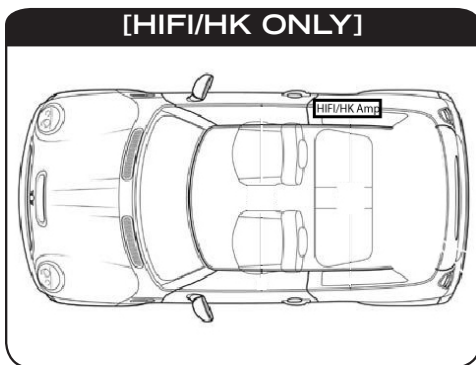

32. HIFI/HK SPEAKER WIRE CONNECTIONS

[HIFI/HK ONLY]

The midrange/midwoofer wires on the HIFI/HK do not pass thru the X9331 and must be tied in at the factory amplifier located in the passenger side quarter panel.

The next steps will guide you thru accessing the HIFI/HK amplifier and making the proper connections.

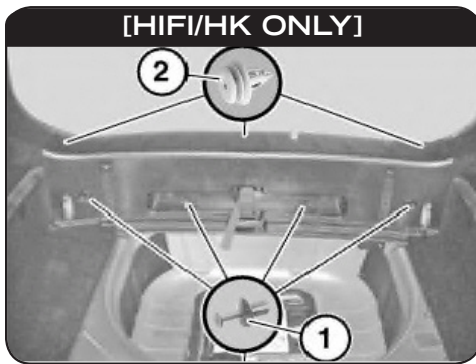

33. REMOVE REAR SILL TRIM

[HIFI/HK ONLY]

Pry out the center pin of expansion rivets (1). Remove the rear sill trim by lifting up, releasing clips (2).

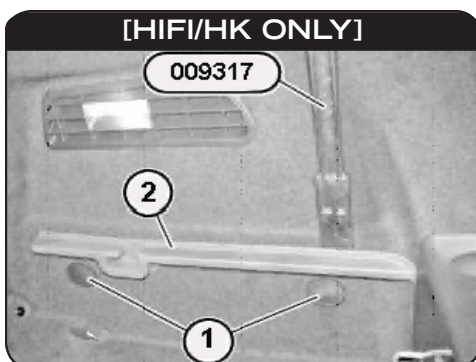

34. REMOVE RIGHT WHEEL ARCH TRIM (PART 1)

[HIFI/HK ONLY]

Pry off cover guide (2) with a prybar or BMW tool 009317. Unclip covers (1) and remove screws underneath.

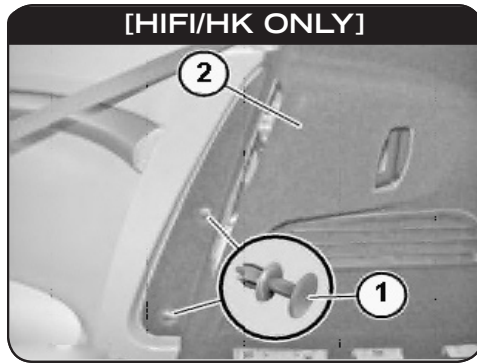

35. REMOVE LEFT WHEEL ARCH TRIM (PART 2)

[HIFI/HK ONLY]

Release expansion rivets (1) by prying out center pin. The trim panel (2) should open enough to access the amplifier.

*Left side is pictured, procedure for right side is the same.

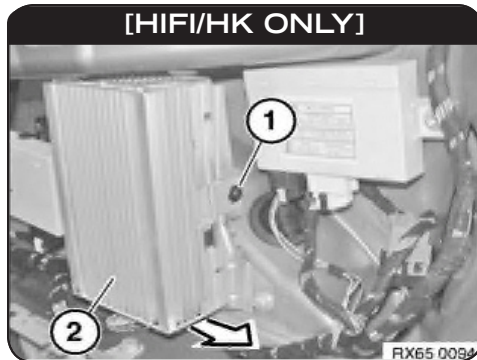

36. ACCESS FACTORY AMP & WIRE LOOM

[HIFI/HK ONLY]

Remove screw (1) with a 10mm socket. Slide amp (2) towards the rear to release. Unplug amplifier connector to access wire loom.

Cut wrapping as needed to access wiring. Do not forget to reconnect the factory amplifier after making the speaker connections.

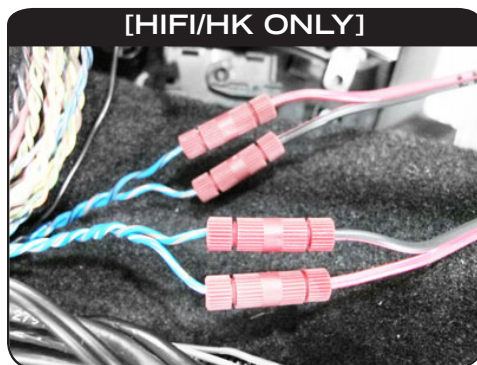

37. HIFI/HK SPEAKER WIRE CONNECTIONS

[HIFI/HK ONLY]

Refer to the chart below. Cut, strip, and connect the wire to the side coming from the car (NOT the factory amp!). Check pin assignments (see following steps) to confirm correct wires - some vehicles have duplicate color pairs!!

HIFI/HK SPEAKER OUTPUT CONNECTIONS

SIGNAL	WIRE COLOR	PIN	CONNECT TO AMP
Front Left ++	Blue w/White Stripe	33	Front Left ++
Front Left --	Blue w/Brown Strip	34	Front Left --
Front Right ++	Blue w/Black Stripe	11	Front Right ++
Front Right --	Bue w/Brown Stripe	12	Front Right --



38. HOW TO CONNECT THREADLOCKS

[HIFI/HK ONLY] The Threadlocks will be used in the next steps for HIFI/HK equipped vehicles. They work like this: Strip 3/8" of insulation from the wire to be connected. Unscrew one end of the Threadlock and insert the wire through the end, then tighten. There should be no exposed wire and the wire should be secured tightly in the connector. These form a mechanical connection that is easily reversible and more reliable than a soldered connection.



39. HOW TO CHECK HIFI/HK PIN NUMBERS

[HIFI/HK ONLY]

Unplug the factory amplifier connector by releasing the locking lever. Gently pry the black plastic housing out to release the locking tab.

Slide the inner connectors out of the housing. You will see the pin numbers marked on the housing. Verify with the chart above



40. AMPLIFIER POWER & SIGNAL CONNECTIONS

Connect the Power, Ground, and Remote Turn-on Lead wires to the amplifier.

Connect the RCA Interconnects. Set the INPUT selector on the amp to "RCA" (2ch amp) or "LOW" (4ch amp)

Attach the amplifier to the mounting plate using the #6 x 3/8" screws.

[SUB ONLY] Connect the RCA's labeled "SUB" to the Rear Inputs of the amplifier.

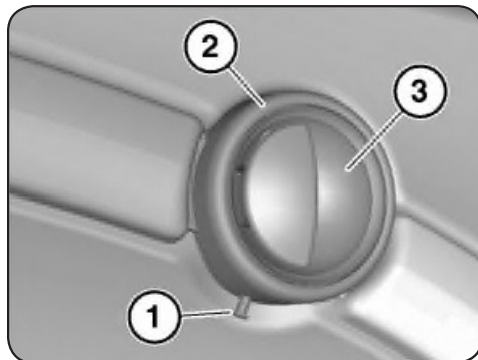

41. REMOVE DOOR HANDLE TRIM RING

Pull pin (1). Leave trim ring (2) in place, it will come off when you remove the door panel.

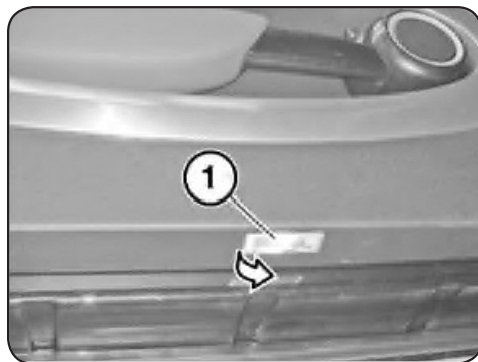

42. REMOVE PUDDLE LIGHT

Pry out Puddle Light (1) from bottom of door. Disconnect and set aside.

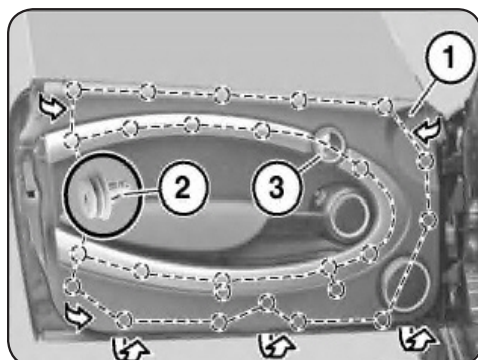

43. REMOVE DOOR PANEL

Remove door panel (1) by pulling firmly inward to release clips (2). Begin at the bottom rear corner and work your way around. Use a plastic panel removal tool to help you get started. The Door Handle Trim Ring will come off with the panel. Set aside with the pin removed earlier - it will snap on after you replace the door panel. Be aware of the door lock indicator on the top/rear when removing the door panel - lift the panel up and over to clear the indicator!

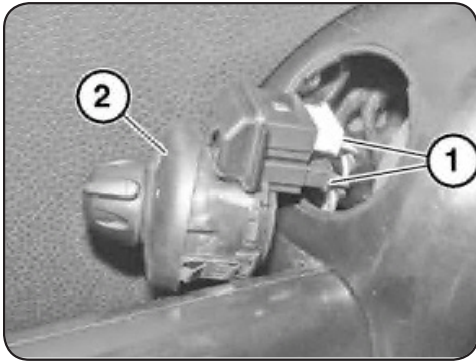

44. REMOVE MIRROR CONTROL

Carefully pry the Mirror Control (2) up at the bottom rear. Once it releases wiggle it up and out. Unplug connectors (1) and set aside.

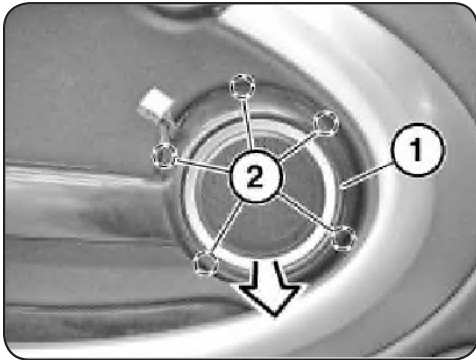

45. MIDRANGE COVER

Pull firmly up and in on the Midrange Cover (1) while pressing inward at the locations of the tabs (2). It is better to pull firmly than to try to pry at the tab locations. Give it a firm pull, it will pop free!

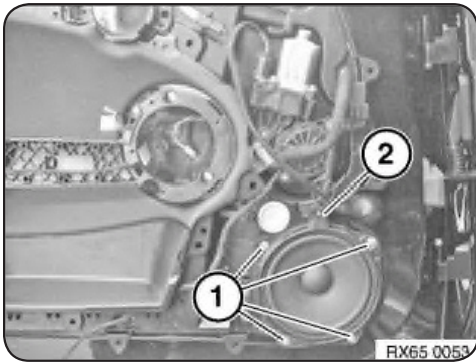

46. REMOVE DOOR SPEAKERS

Remove the woofer mounting screws (1) with a Torx T-25. Unplug the speaker connector (2). Repeat for the door midrange. Keep the Torx screws - they will be used to mount the new speaker adapters.

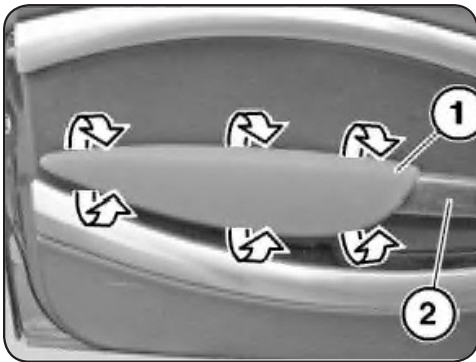

47. REMOVE ARMREST COVER & TRIM

Remove Armrest Cover (1) by levering up the edges of the trim in the directions indicated by the arrows.

Remove the trim cover (2) by releasing the two Torx-25 screws at either end.

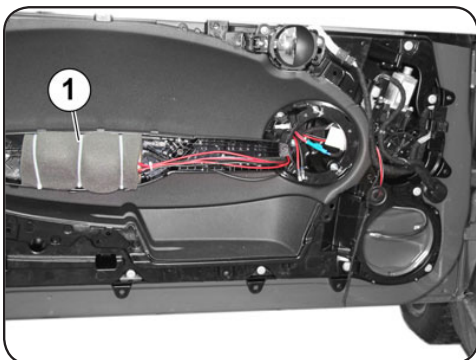

48. MIDRANGE/MIDWOOFER (OVERVIEW)

The Midrange/Midwoofer crossover network (1) installs in the cavity behind the door armrest cover. The wiring harness connects to the factory midrange connector (blue). The wiring harness is routed behind the armrest trim and through the hole at the back of the midrange cover to the factory connector and the midrange driver. The wire for the woofer continues behind the midrange, down and through the rubber grommet and on to the back of the midwoofer.

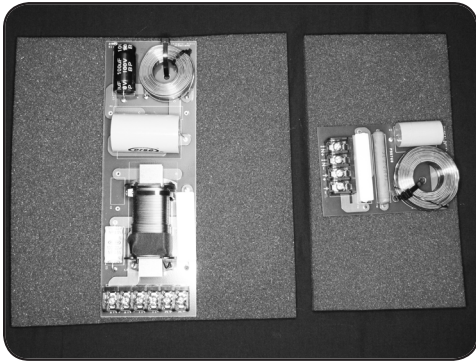

49. COVER CROSSOVERS WITH FOAM PADDING

The crossovers get wrapped in foam padding, secured by zipties.

The square pieces of foam are for the midrange/midwoofer crossover, the narrow rectangular pieces are for the tweeter crossovers

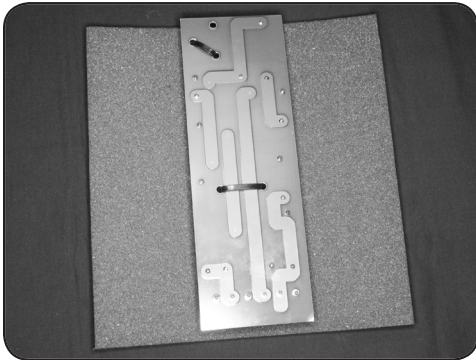

50. COVER CROSSOVERS WITH FOAM PADDING

Place each crossover component-side down. You want the seam of the foam to be on the smooth printed circuit board side of the crossover. Make sure the terminal connections for the wiring harness are on the open end.

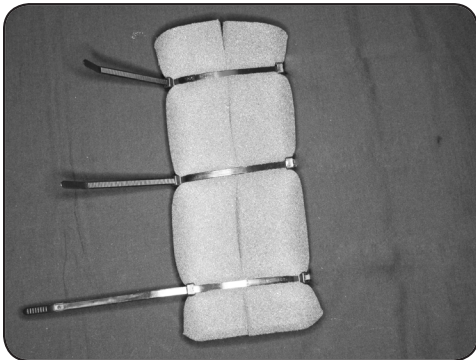

51. COVER CROSSOVERS WITH FOAM PADDING

Wrap the foam around each crossover and secure with (3) zip-ties for the midrange/midwoofer crossover, and (2) zipties for the tweeter crossover

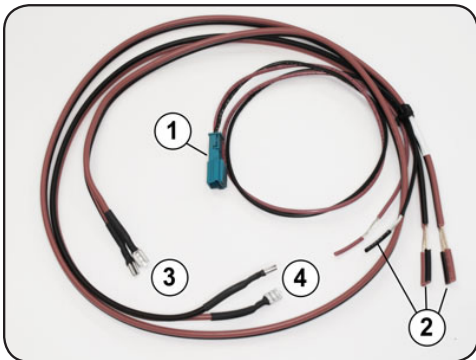

52. MIDRANGE/MIDWOOFER WIRE HARNESS

The wiring harness for the speaker and crossover connections to the door speakers has been pre-fabricated. Connector (1) will plug directly into the factory midrange connector. The 18" branch (3) connects to the midrange driver. The 36" branch (4) connects to the woofer. The stripped ends (2) connect to the crossover in the armrest.

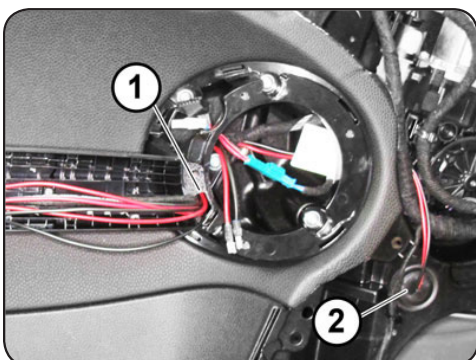

53. ROUTE & CONNECT WIRE HARNESS

Route all wires through the opening (1) at the rear of the mid-range cavity. Connect the blue connector to the factory midrange connector. Leave the midrange wire in the midrange cavity. Continue running the woofer wire behind the midrange cavity, then out and down to the rubber grommet (2). Using a utility knife, cut a small slit in the grommet and run the woofer wire through and into the door cavity. Be certain all wires are clear of any moving parts or obstructions!

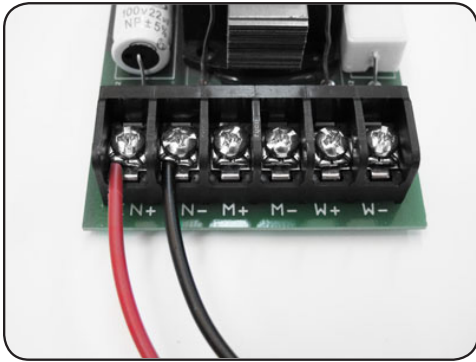

54. CROSSOVER CONNECTIONS

Connect the stripped wires ends to the crossover board. The branch from the blue connector connects to the “IN”. The mid-range branch connects to “M”, and the woofer branch connects to “W”. Red is + and Black is - for all three.

Place the Crossover in the armrest cavity. The armrest cover will hold it in place. **IMPORTANT:** on some 2013+ models, there may be a plastic screw boss in the way. This screw boss can be cut away if it interferes with crossover placement.

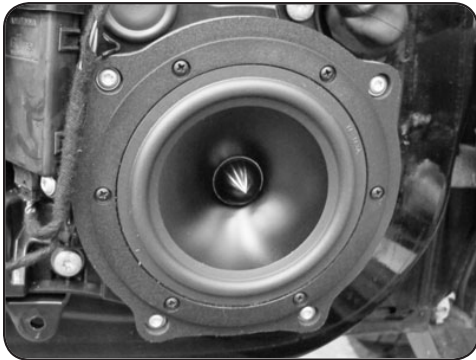

55. MOUNT MIDRANGE & MIDWOOFER

Mount the Woofer Adapter to the door with the factory Torx screws removed earlier. Connect the woofer wiring, making sure the connectors lock to the speaker tabs. Use wire ties to ensure that the woofer wiring is clear of the window mechanism! Mount the woofer with the #8 x 1/2” black oxide screws.

Repeat the process for the Midrange, using the #6 x 3/8” screws.



56. TWEETER INSTALLATION (OVERVIEW)

The Soundstage Tweeters install directly into the factory tweeter mounts on the A-Pillar trim (the trim at either side of the windshield). The tweeter crossover networks install in a small compartment on either side of the dashboard. The crossover input connects to the tweeter wire from the amp and the 18” tweeter pigtail connects to crossover to the tweeter.

[6SPK ONLY] The new A-pillar trim is included

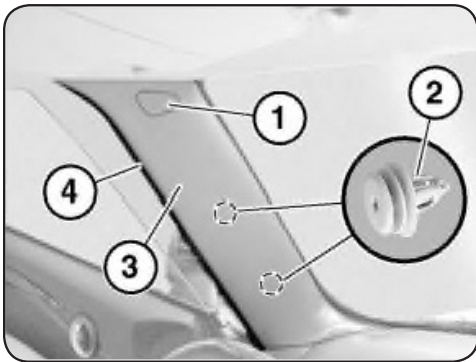

57. REMOVE A-PILLAR TRIM

Carefully lever/pry out screw cap cover (1). Remove the T-20 Torx screw underneath. Loosen the door seal (4) to gain access to the edge of the trim piece (3). Pull inward to release clips (2). Disconnect the tweeter wire and remove the the trim piece.

[6SPK ONLY] You will not be reusing this trim piece

[HIFI/HK ONLY] You WILL be reusing this trim piece.

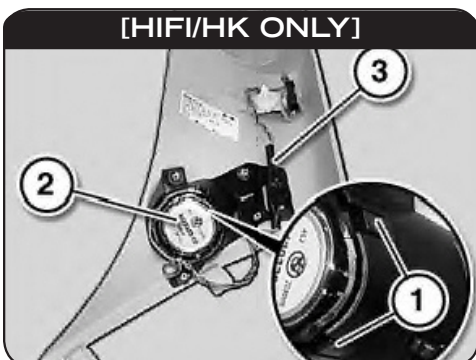

58. REMOVE EXISTING TWEETER

[HIFI/HK ONLY]

Release tabs (1) and remove tweeter (2). Unclip capacitor and wire (3) and remove.



59. REMOVE/REPLACE TWEETER BADGES

[2010+ HK ONLY]

Remove the “Harmon/Kardon” tweeter badge by prying up gently with a flat screwdriver. You need to insert the blade into the thin gap between the badge and the backing plate, not between the backing plate and the grill material. Replace with the adhesive Integral Audio badge by removing the backing and affixing in the recess in the tweeter grille.



60. INSTALL TWEETER

Press the new tweeter squarely and firmly into the housing until it locks into place. The “I” logo should be vertical.

NOTE: On some cars the tweeter mount may be warped, making a very tight fit. If you can't get all the tweeter latches to lock, use a small dab of cyanoacrylate (superglue) at the tab location.



61. OPEN DASHBOARD SIDE COMPARTMENT

Using a panel removal tool, lever open the plastic cover on the side of the dashboard. Run the tweeter wire coming from the amp up the side of the door jam and into this compartment.



62. INSTALL & CONNECT TWEETER CROSSOVER

Connect the tweeter wire from the amp to the “IN” terminals on the tweeter crossover. Connect the 18” Tweeter Pigtail to the “T” outputs. Route the pigtail up to the base of the A-pillar for connection to the tweeter. Place tweeter crossover (1) into compartment.

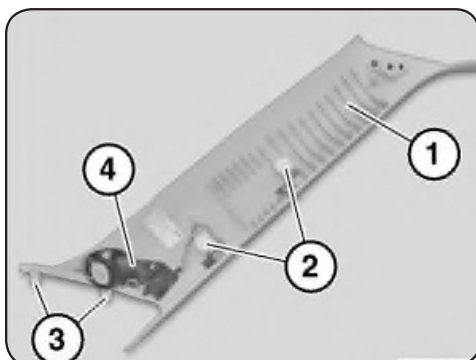

63. REPLACE A-PILLAR

Connect the tweeter wire pigtail to the tweeter (4). Replace the A-pillar trim (1). Take care to ensure that the tabs (3) and clips (2) align with their corresponding holes on the vehicle, and that the clear rubber sleeves are protecting the metal tweeter tabs. The tabs (3) can be a little tricky - it helps to use a panel tool between the trim and the windshield to force the tabs inward and into the holes. Do not replace the screw and screw cover yet (wait until after testing!)

SEE PREVIOUS IMAGES

64. REPEAT FOR THE RIGHT SIDE

Repeat all of this section for the other side of the vehicle. Obviously, you can omit the steps relating to the mirror switch!



65. SUBWOOFER INSTALLATION

This entire section applies only to the subwoofer installation. If you are not installing the subwoofer system please proceed to Testing & Recommended Settings.



66. INSTALL NEUTRIK SPEAK-ON PLUG

Split and strip the end of the Subwoofer Speaker wire. Slide the blue threaded bushing back. Thread the speaker wire through the bushing and the inner bushing. Loosen the clamping screws, insert each wire (observing the polarity markings on the connector), and tighten the screw. Snap the blue threaded bushing back down and thread down firmly.



67. ATTACH THE MOUNTING BRACKETS

Align the Mounting Brackets over the pre-drilled pilot holes on the sides of the enclosure and attach using the (8) #10 screws.



68. THREADED INSERTS (OVERVIEW)

Self-Sealing Threaded Inserts are used to secure the enclosure to the vehicle. It is important that you follow these installation steps carefully and completely. An extra Insert is provided in case you run into trouble.



69. REMOVE ASPHALT PATCH

On the driver's side of the boot floor you will see an approximately 2" x 2" asphalt patch. Use the stiff putty knife to remove it. It should remove easily, if not heating it with a heat gun (or hair dryer) will soften it. Cut a short strip of electrical tape and cover the hole - the enclosure side leg will sit over the hole.



70. MARK FOR BRACKET AND THREADED INSERT

Temporarily replace the Wheel Arch Trim Panels, if previously removed. Place the enclosure in the boot, all the way forward and centered side-to-side in the carpet opening. Using a center punch (or marker), mark the center of the mounting bracket hole in the sheet metal below. Keep the hole at least 3/8" away from the edges of the raised/lowered area of the sheet metal. Cut a notch in the carpet by cutting two slits and folding the carpet back and under. Mark the center with a marker or center punch.



71. INSTALL THREADED INSERTS (PART 1)

Using a 7/16" bit (NOT a 1/2" bit!), drill holes in the 2 positions marked on the boot floor. Do not let the drill bit penetrate more than 1/4" through the sheet metal. You may find it helpful to use a cut-to-length wood block as a stop for the drill. It is important to drill the holes EXACTLY where they were marked. Remove any metal burrs - the hole must have clean edges.

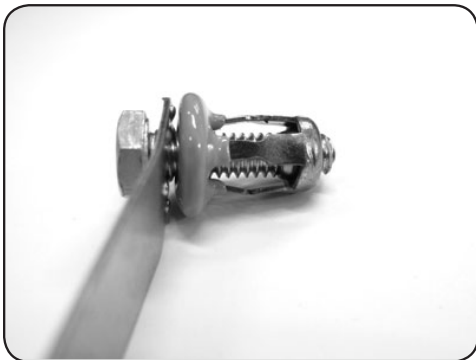

72. INSTALL THREADED INSERTS (PART 2)

Using a utility knife, carefully trim the PVC jacket out of the center of the Self-Sealing Threaded Inserts as shown. Insert the 1" Hex Bolt through the Installation Tool. Then thread the 1" Hex Bolt into the Threaded Insert. Be sure the "nubs" on the Installation Tool face the top of the Threaded Insert. These "nubs" are what grip the Insert and prevent it from turning during installation.



73. INSTALL THREADED INSERTS (PART 3)

Insert the Threaded Inserts into the holes drilled in the previous step. Keep the Insert vertical and keep the head of the Insert flush against the sheet metal and carefully tighten the bolt by hand with a wrench (do not use a powered tool of any kind) until you begin to feel resistance and the insert is secure. Take your time - do not over-tighten. Remove the 1" Hex bolt. If you have trouble with an Insert, you can remove it by partially unthreading the 1" Hex bolt and tapping it with a hammer.

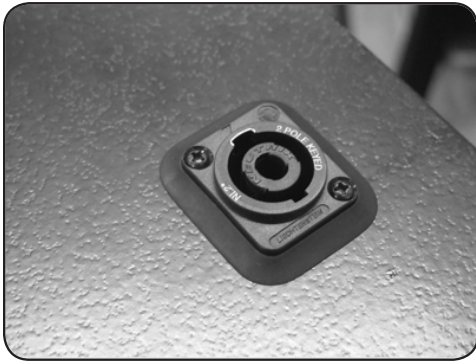

74. WIRING & NEUTRIK PLUG

Connect the subwoofer internal wiring harness to the back of the Neutrik Speak-on connector (observing correct +/- polarity). Place the Speak-on gasket over the connector, thread the wire through the mounting hole, and mount the Speak-on connector using the (2) #4 x 1/2" screws.



75. MOUNT THE SPEAKER

Mount the speaker with the #10 x 1" Black Pan Head Screws. Tighten the screws in a "star" pattern, go slowly and take care not to strip them. Make sure the speaker flange is flush against the enclosure – the gasket on the back of the speaker flange **MUST** make an airtight seal.

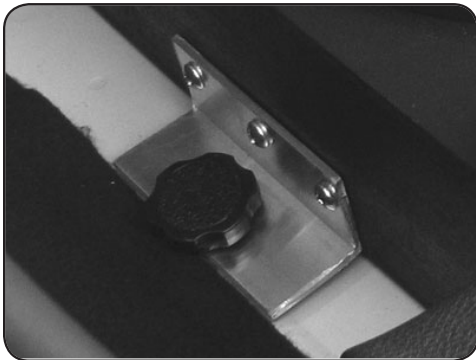

76. INSTALL THE ENCLOSURE

Place the enclosure back into the boot. Connect the Neutrik connector. Insert the Rosette Thumbscrews through the Mounting Brackets and screw into the Threaded Inserts. If you made a mistake drilling the holes and the Thumbscrews do not line up, you can drill larger holes in the mounting brackets.
NOTE: We recommend coating the threads of the Rosette Thumbscrews with grease to keep them operating smoothly and avoid corrosion.



77. INSERT THE FALSE FLOOR

The carpet covered trim panel covers the area left exposed over the lower boot area. Simply place the false floor into and over the exposed area.

Take this opportunity to verify that the speaker has at least 1" clearance between it and anything under it (tool caddy, etc).



78. HOW TO REMOVE THE ENCLOSURE

To remove the enclosure, simply disconnect the speaker wire, unscrew the Rosette Thumbscrews, and remove.

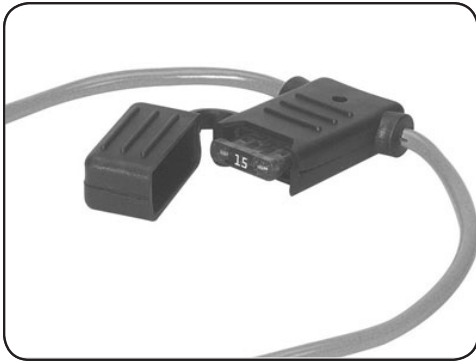

79. RECONNECT THE BATTERY & INSTALL FUSE

Reconnect the Battery Negative Terminal and install the fuse in the fuse holder.

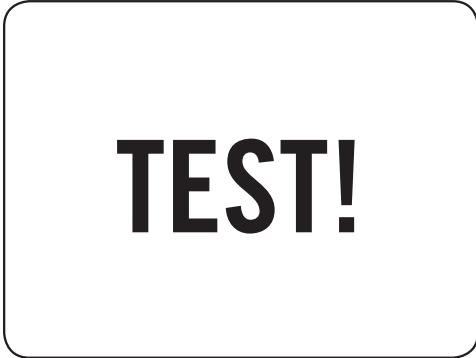

80. SETUP & TUNING

YOU MUST DO EACH STEP EXACTLY AS DESCRIBED. IF POSSIBLE, HAVE SOMEONE ELSE READ THE INSTRUCTIONS TO YOU WHILE YOU PERFORM THE STEPS.

Do not reinstall any panels until you have confirmed that everything is operating properly.



81. REPLACE SEATS & RECONNECT AIRBAG WIRING

If you removed them, replace the seats in vehicle and reconnect the yellow connector under the seat. You do not need to bolt the seat down yet. For under-seat amp installs, you can lean the seat back to gain access to the amp for settings.

Reconnect the vehicle battery.

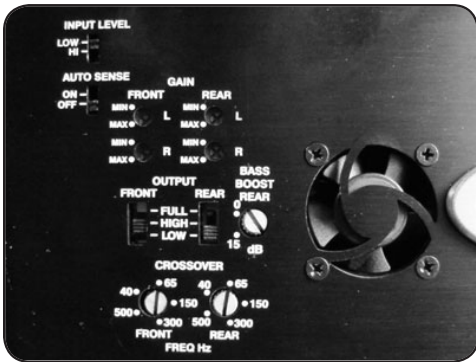

82. INITIAL AMP SETTINGS

Input Level: LOW. (on 2ch amp, look for a button on amp end)
 Auto Sense: OFF. (4ch amp only), BX2: OFF (2ch amp only)
 Gain (aka input sensitivity): minimum on all 4 channels.
 Output -> Front: HIGH (with Sub), FULL (w/o Subwoofer)
 Output -> Rear (i.e. subwoofer): LOW [SUB ONLY]
 Crossover -> Front: turn dial to minimum (full counter-clockwise). Note which part of the dial is pointing to 40Hz. Turn until that part points to 65Hz. Repeat for the Rear (subwoofer) Crossover.



83. SET GONG VOLUME TO MIN [BOOST AUDIO]

If your speedo looks like the picture at right, you have BOOST Audio.

Select the music note button to bring up the tone controls. Scroll to the right. Set the gong volume to the lowest level Return to the tone controls menu and set BASS and TREBLE to flat. (THESE ARE CRITICAL)

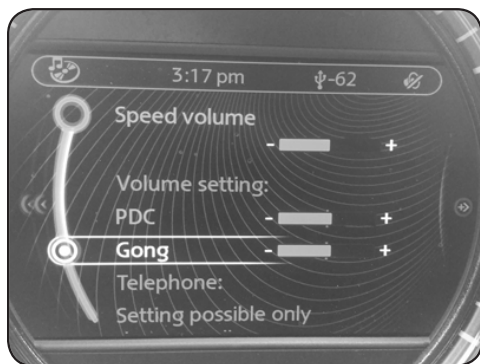

84. SET GONG VOLUME TO MIN [NAV & MINI CONNECTED]

If your speedo has a large screen at the center, you have Nav or MINI Connected.

From the music control section, select TONE -> VOLUME SETTINGS -> GONG. Set the gong volume to the lowest level (Return to the tone controls menu and set BASS and TREBLE to flat. (THESE ARE CRITICAL)



85. SET FRONT CHANNEL GAIN

We recommend setting the front channel gains to minimum as a starting point. This will give you the highest signal to noise ratio.

This controls the total system max volume. In 99% of cases this will be more than adequate. If you find the system doesn't play loud enough for you at top volume, come back here and re-adjust higher, then proceed through the rest of the setup steps again.



86. MATCH FRONT CHANNEL GAINS

Play a 500Hz test tone from CD. Set your voltmeter to read AC voltage. Check the voltage across the Front Right positive & negative speaker terminals on the amp. Turn the headunit volume up until you see 1V output (again, adjust the headunit volume – do not change the gain on the amp).

With the test tone still playing, check the output voltage on the Front Left and Right channels. If one is lower than the other, adjust the LOWER channel up until it matches the higher channel.

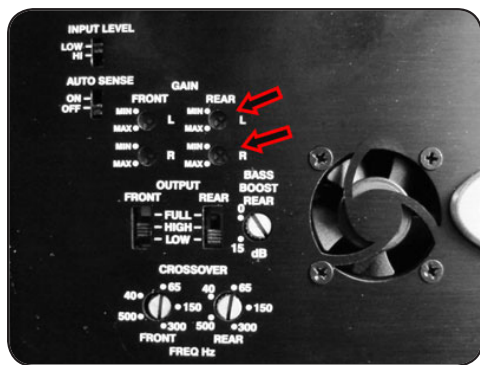

87. SET SUBWOOFER GAIN (REAR AMP CHANNELS) [SUB ONLY]

Disconnect the subwoofer Neutrik terminal (or wear hearing protection). Leaving the headunit volume where it is, play a 40Hz tone. Turn the subwoofer remote volume control to maximum. Check the output voltage at each Rear channel output. Adjust until each channel reads the correct voltage for your vehicle as Then check the bridged output voltage (i.e. check across the outer terminals where the subwoofer output wires are connected) and confirm that it is double each individual channel. When you are done, turn the subwoofer remote volume control back to the middle. Reconnect the subwoofer Neutrik terminal.

NOTE: if the headunit turns off during this process, you can turn it on again by pressing in on the volume knob on the headunit. Just re-confirm that you have 1V output on the front channels, the headunit volume again if necessary to get back to 1V.

R55 & R56: 3.5V per channel, 7V bridged

R58: 4.5V per channel, 9V bridged

R57 & R59: 5V per channel, 10V bridged

Verify that each speaker is playing correctly.



88. CONFIRM SPEAKER CONNECTIONS & SETTINGS

In the headunit, turn the Balance control to fade fully Left. Start at 20Hz on the test tone CD, play/skip through each higher frequency to 4kHz. You should hear the subwoofer first, then at ~60Hz you'll transition to the door mid-woofer, then at ~150Hz you'll transition to the midrange, and then the tweeter beginning at ~2.5kHz. You should hear each speaker on the left, in the correct order. You may get some sound from the right, but it should be low level. Then fade the Balance all the way to the Right and repeat the process for the right side.

89. AMPLIFIER CROSSOVER SETTINGS

Reset the Balance in the headunit to center. With the doors closed and windows up, play through each test tone frequency starting at 20Hz and going up to about 150Hz. As you skip through, each frequency should seem to be about the same volume level. If you find you have too much bass in the 60-70Hz region, adjust the Front Crossover on the amp up a bit and repeat. If you find you don't have enough bass there turn the Front Crossover down and repeat. On R55 & R56 vehicles, you will likely find that you end up with the subwoofer crossover set around 65Hz and the front crossover at around 55Hz. On R57, R58, and R59 vehicles you will probably have the subwoofer crossover at around 70Hz and the front crossover at around 50Hz. You may end up with different settings due to preference and the fact that the potentiometers in the amp don't have a precise dial setting.



90. SET FRONT/REAR FADER LEVEL

Turn the Fader setting in the headunit to fade all the way to the front (i.e. no sound from rear speakers). With the doors closed and the windows up, play music. Turn your head all the way right, as though you were looking at the passenger. Fade back to the rear until it no longer sounds "empty" behind you. This is the correct front/rear balance.

REFER TO THE MINI COOPER OWNER'S MANUAL!

91. SET AUX INPUT LEVELS

If you use any device (mp3 player, sat radio receiver, etc) that uses a headphone out jack as input to the AUX IN, set the volume on that device to approx. 80-90% of full volume. Adjust the AUX IN level setting in the headunit to around 60-80% of full volume. The volume setting for the AUX input on the headunit can be accessed by pressing and holding the right side of the 4th button from the right. The factory default is 2. We recommend a starting setting of 4. Please refer to the MINI Manual for setting the Aux level on NAV and MINI Connect equipped vehicles.



92. ROCK. AND ROLL.

That's it! You should be ready to rock and roll. If you aren't seriously impressed by the sound, something is wrong. Trust us on this. It should be clean, clear, and balanced. If it isn't, revisit the steps above or reach out to us for support at 646-926-0011 or email us at support@integralaudio.com.

REFER TO PREVIOUS STEPS!

93. REPLACE ALL PANELS & TRIM

All parts, panels, and trim install in the reverse order they were removed.



94. INTEGRAL AUDIO LOGO BADGES

[All Vehicles EXCEPT 2010+ with HK]

Remove the paper backing and affix the adhesive Integral Audio badges in the location of your choice. We recommend placing them on the lower section of the woofers as indicated (1). The adhesive sets up over a 48 hour period. The badges can safely be repositioned 2 or 3 times within the first 10-15 min after application.

- **AMPLIFIER TURN-ON:** You will notice that the amplifier turns on before the head unit, and remains on after the head unit is off. This is normal. The sound output system needs to be energized to play your door chimes, parking distance control sounds, bluetooth, etc. The amp will turn on from the moment the doors are unlocked or opened, and remain on from between 30 seconds and as much as 20 minutes after the car is locked. Again, this is perfectly normal. The idle current on the ARC amp is virtually zero and will not cause any issues with battery drain.
- **SIGNAL SOURCE QUALITY:** A poor quality signal will always sound poor no matter how good an audio system is. If you are using MP3s or home-burned CDs it is critical that you understand the limitations and impacts of digital compression methods. MP3s at less than 256kbps will have noticeable loss of quality. Satellite radio is also compressed and will have similar quality issues. Non-commercially obtained music (especially downloaded via P2P file-sharing) recordings are often re-mixed by third parties and will have been compressed in an unknown and uncontrolled manner. If you want good quality sound, use only commercial CDs or MP3s compressed at 256kbps or 320kbps.
- **FACTORY RADIO SETTINGS:** Please note that the settings (Bass, Treble, Fade, Balance, AUX input level, etc.) are stored on the Key FOB & are specific to the Source (Radio, CD, AUX). You will need to edit and save the settings for each source and each FOB to have consistent sound.
- **PLEASE LISTEN RESPONSIBLY:** Your new Integral Audio system is capable of delivering Sound Pressure Levels that can damage your hearing. It also delivers very clean, low-distortion sound reproduction. Because distortion sounds bad to your ears, and low-distortion sounds good, you are much more likely to listen at high levels with your new system. Please exercise caution - we want you to enjoy a lifetime of great sound!

Having Trouble? The best thing to do is contact us at support@integralaudio.com or via the phone number listed on the receipt that was emailed to you. We'll get you fixed up ASAP!